

# Flooring design & installation

COSENTINO® FLOORING  
DEKTON® FLOORING. DESIGN & INSTALLATION



## Index

Design criteria	4
Product features	4
Flooring characteristics and formats	6
Patterns and design	8
Other considerations	10
Basic characteristics of the substrate	11
Thickness and format according to application	16
Dekton® Grip/Grip+	17
Joints	18
On-site/Workshop placement	19
Palletizing and transport of material to the construction site/workshop	19
Manufacturing & installation	20
Cutting tiles in the workshop	20
Cutting tiles on site	21
Basic characteristics of adhesives and grouts	22
Tools for manufacturing and installation	23
Installation process and recommendations	24
Health & safety	28

## Design criteria

### Product features

Dekton® has all the technical features required for any hard surface, even in a demanding application such as flooring.



→ Fireproof material

Dekton® is ideal for use in evacuation routes, as it is non-combustible. It is classified at the highest level in accordance with the European EN 13501 and North American ASTM E84 standards.



→ Highly resistant to UV light

Dekton® is highly resistant to ultraviolet (UV) light and will not fade or degrade over time in an outdoor flooring application.



→ Maximum heat resistance

Dekton® is ideal for flooring in areas exposed to high temperatures, even with dark colors, as well as for underfloor heating and other thermally demanding industrial applications.



→ Easy cleaning and low maintenance

The excellent resistance of Dekton® to all types of chemicals facilitates the cleaning of floors in hospitals, laboratories and industry facilities in general, without the need to use expensive abrasive systems.



→ Low water absorption

Dekton®'s water absorption is negligible; durability is ensured even with regular wet cleaning.



→ Color durability

The raw materials used for the manufacturing of Dekton® ensure the durability of all the shades that make up each color, in all weather conditions, preventing discoloration over time.



→ Scratch resistant

Dekton® is one of the best materials to use when you cannot avoid the movement of chairs, tables and other objects that may scratch the floor.



→ Stain resistant

Dekton® features ultra-compactness, virtually zero porosity and inorganic composition that prevents stains from penetrating or setting on the tiles permanently, and can be cleaned after months without the need for treatment.



→ Dimensional stability

The ultra-compact properties of Dekton® stand out in terms of flatness, zero warping, straight shapes and maximum precision between tiles.



→ Resistance to freezing and thawing

Dekton®'s resistance to thermal fatigue tests in freezing and thawing situations makes it a suitable material for outdoor use in harsh environments, such as floors in industrial refrigeration facilities.



→ Abrasion resistant

Dekton® is among the best materials for commercial high-traffic, heavy-duty applications.



→ Superior mechanical resistance

Whether the Dekton® floor has to withstand heavy loads or is a raised access floor, its excellent compressive and bending strength, combined with the right thickness, ensures the necessary durability.

## Flooring characteristics and formats

Thanks to its high performance, and with proper installation, Dekton® can be laid in large formats guaranteeing optimal results, even in high traffic areas.

It should be noted that substrate conditions are essential to ensure a good installation. The suitability of the laying surface should always be checked beforehand and must be:

- Healthy and free of cracks.
- Treated and stable throughout.
- Mechanically resistant to support the loads and their use.
- Dry, clean and without loose pieces.
- Flat, taking into account the maximum tolerance.

The right format and thickness of Dekton® will depend on local regulations and project requirements and will need to be verified by those undertaking the project.

The use of 4 mm thickness for flooring application is strictly PROHIBITED in all cases.

For more technical information on Dekton®, please refer to the product *Technical Data Sheet*.

<b>Full slab format</b>	3,200 x 1,440 mm [126" x 56"]
<b>Thicknesses</b>	8 mm - 12 mm - 20 mm
<b>Finishes</b>	Smooth, textured, polished and Grip/Grip+ (wet areas)

Dekton® is highly versatile. With it, you can customize pieces for your project depending on the design, starting from a full slabs.

However, the recommended formats to maximize the use of Dekton®, starting from a full slab, are as follows:

Format (mm)	No. of pieces
710 x 710 [28" x 28"]	8
710 x 1,060 [28" x 42"]	6
710 x 1,420 [28" x 56"]	4
710 x 1,590 [28" x 63"]	4
1,060 x 1,420 [42" x 56"]	3
1,420 x 790 [56" x 31"]	4
1,420 x 1,420 [56" x 56"]	2
1,420 x 1,590 [56" x 63"]	2

- This is assuming a 3 mm [1/8"] wide cutting disc.
- Any other format is possible, up to a maximum of a full slab.
- Tolerances in accordance with EN 14411:2016 (Ceramic tiles).

	1,420 x 1,420 [56" x 56"]	1,420 x 3,200 [56" x 126"]	1,420 x 1,590 [56" x 63"]	1,420 x 1,060 [56" x 42"]	1,420 x 790 [56" x 31"]
710 x 710 [28" x 28"]	710 x 1,420 [28" x 56"]	710 x 3,200 [28" x 126"]	710 x 1,590 [28" x 63"]	710 x 1,060 [28" x 42"]	

→ All dimensions in mm.

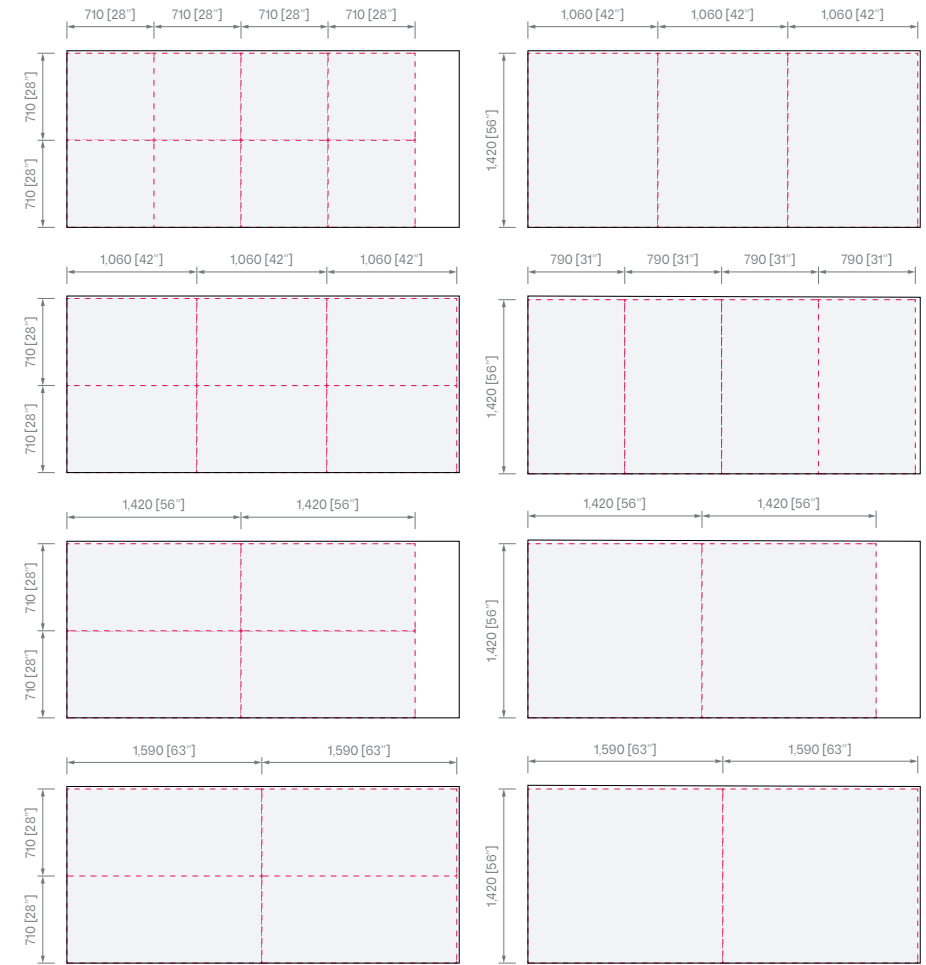

→ All dimensions in mm.

## Patterns and design

We have classified our Dekton® color range into three different clusters of patterns to facilitate the design process.

All our portfolio is labeled as *Infinite Pattern*, *Singular Pattern* or *Smooth Pattern*, depending on the desired effect for large surfaces and the placement of slabs adjacent to one another, taking into account the orientation of the design, shades and variations.

However, this classification is merely indicative and we recommend that you contact our *Product Department* to obtain an individual assessment that guarantees how you can materialize your project the way you imagined.

### → Infinite Pattern

Uniform colors or designs with a consistent or almost consistent composition and structure that, when used for cladding such as floors, walls or facades, allow for random placement of slabs, providing a beautifully consistent look. Please note that cuttings are subject to shade variations. Recommended for cladding large surfaces.

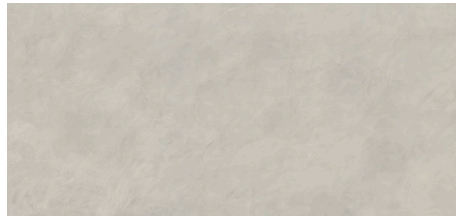

→ Dekton® Argentium kC.

### → Singular Pattern

Designs with color ranges of greater complexity and a very strong orientation, which result in patterns with a lot of character and variation in smaller cuts or continuous layouts. We recommend consulting our technical team for use on large surfaces.

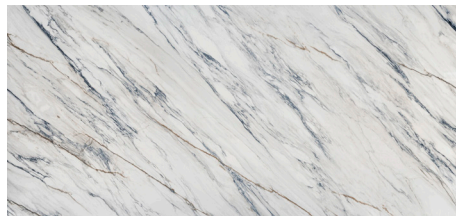

→ Dekton® Trance kC.

### → Smooth Pattern

Designs with an orientation in the graphic structure that has to be taken into account when cutting and placing the slabs. It is a very versatile type of pattern that requires consideration of orientation in its installation. Recommended for large surfaces.

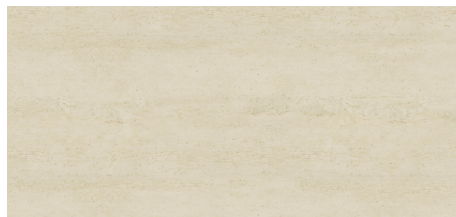

→ Dekton® Danæe kC.

In addition, since Dekton® patterns have been designed for a large format (full slab), it is possible that, in the smaller formats used for flooring, color irregularities, certain contrasts or changes in orientation between the tiles may be observed.

It is therefore advisable to take this into account from the design phase.

#### Option A

Veining parallel to the tile.

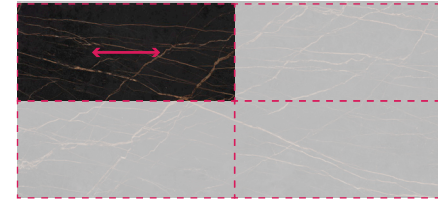

#### Option B

Veining perpendicular to the tile.

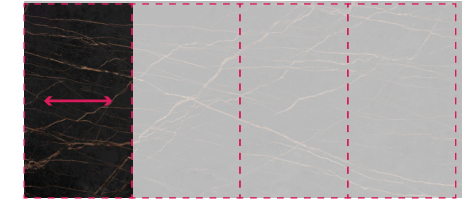

→ Dekton® Laurent - Differences in veining orientation depending on the selected cutting pattern and format.

### → Non-correlated tiles

In this case, the tiles are placed without regard to the order or pattern in which they were cut.

This random placement achieves a very natural effect, but the end customer must be informed of this from the very beginning.

However, it will also depend on the Dekton® color chosen, as randomness will be much more evident in patterns with a wide range of tones.

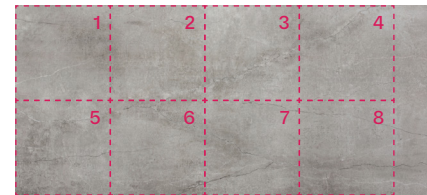

→ Dekton® Soke - Non-correlated placement pattern.

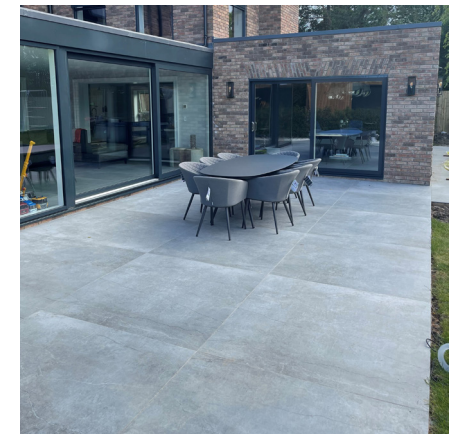

→ Middle Northumberland (United Kingdom), Houses.

## Other considerations

→ Joints with pillars, cut-outs or other elements

L-shaped tiles cannot be used under any circumstances, as in case of breakage, it would not be covered by the warranty.

Therefore, in order to deal with joints with elements that 'break' the continuity of the flooring, it is recommended to divide it into as many pieces as necessary. The aim is to avoid loose and flimsy 'arms' on the floor tiles, as this area of the material is very susceptible to breakage.

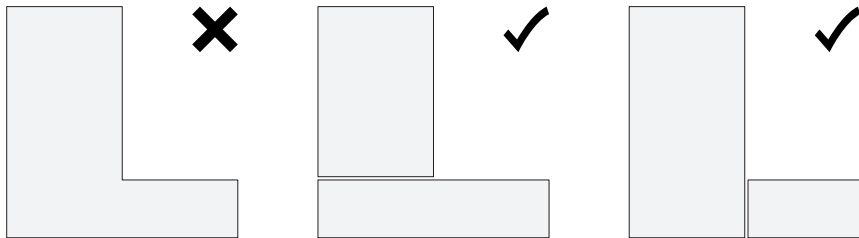

Below there are some examples of how to solve the encounter with different elements:

→ Pillar

→ Embedded pillar/wall

→ Cut-out

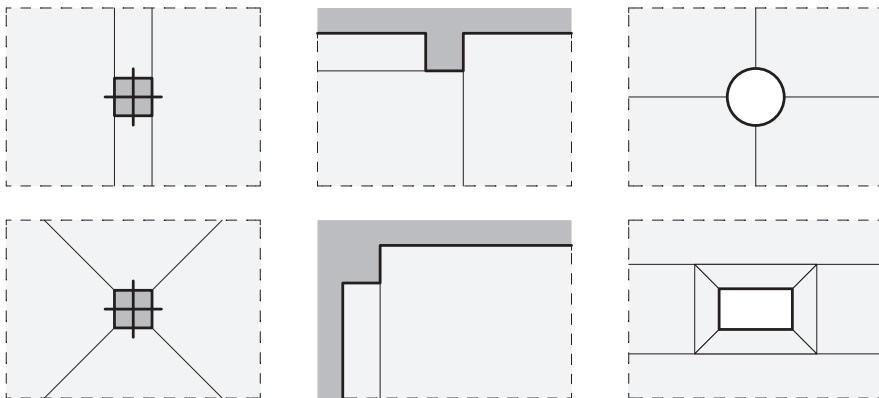

## Basic characteristics of the substrate

1. The substrate on which Dekton® is to be laid must be suitable to support the loads and meet the requirements of its intended use.
2. It must be dry, stable and have compressive strength.
3. It must be free of unevenness or slope (maximum 3 mm [1/8"] measured with a 2.000 mm [79"] metal ruler).

Otherwise, it must be properly smoothed over or treated with a self-leveling layer.



→ Negative deviation: WITHIN tolerance.

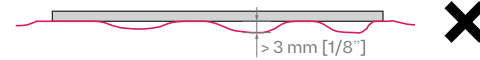

→ Negative deviation: OUT of tolerance.

4. It shall be free of dust, grease, oil, glaze, release agents, curing liquids or any other product that could impair adhesion.

If necessary, it must be cleaned beforehand: milling, vacuuming, descaling, etc.

5. In general, there are three main parts of a floor:

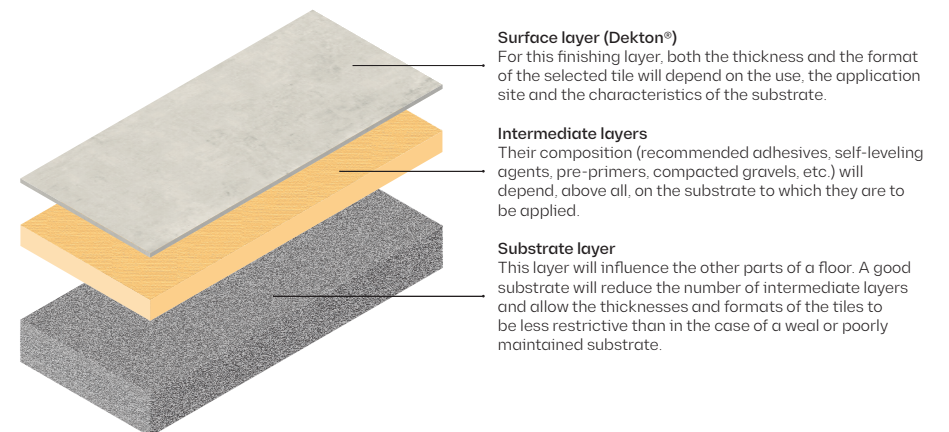

The following are the most common examples from the wide variety of situations that can occur:

→ New construction site

The substrate is assumed to be in an optimal state on which the rest of the necessary layers will be placed.

In any case, the technician in charge of the project will certify that the substrate complies with the conditions described above.

**Bonded to concrete substrate**

- Check the flatness of the substrate.
- Clean beforehand.
- Lay the Dekton® tiles using the recommended adhesive.

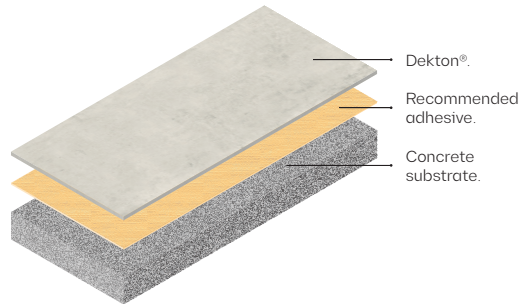

**Underfloor heating**

- Consult the supplier of the underfloor heating system for installation details.
- For information on the appropriate adhesive, please consult the *Product Approval Sheets* for recommended adhesives published by Cosentino®.

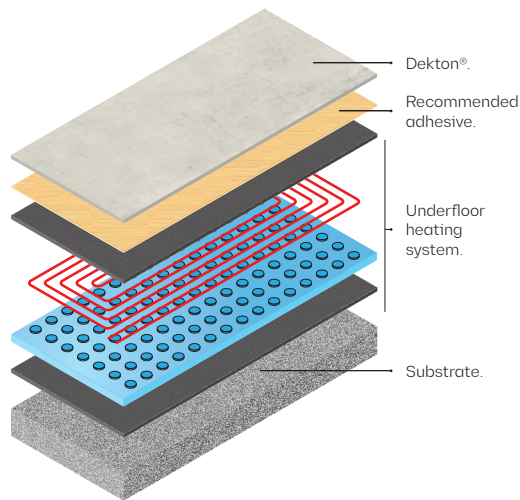

**Raised floor**

- For foot traffic use only.
- Dekton® thickness: 20 mm.
- The material must always be supplied with mesh, on its back side, by Cosentino® (Protek).
- For further details and technical information, please refer to the *Specification Sheet* published by Cosentino®:

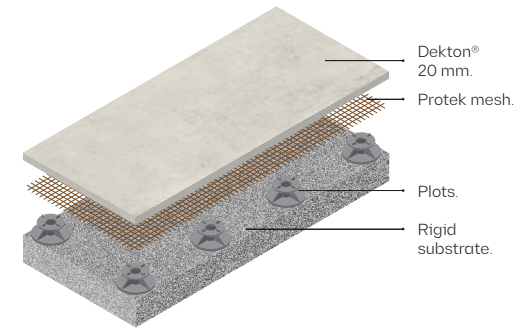

- Types of plots to be used.
- Distances between plots.
- Recommended number of plots.
- Recommended bevels.
- Joints between tiles.
- Cleaning and maintenance.

**Floating flooring in garden area**

- Plan the design and excavate the area as thick as necessary to accommodate all layers.
- Consider calculating a 2% slope for proper drainage.
- The area needs to be compacted.
- The use of two layers of different grain size is recommended.
- Use a geotextile sheet before adding the final layer of sand.

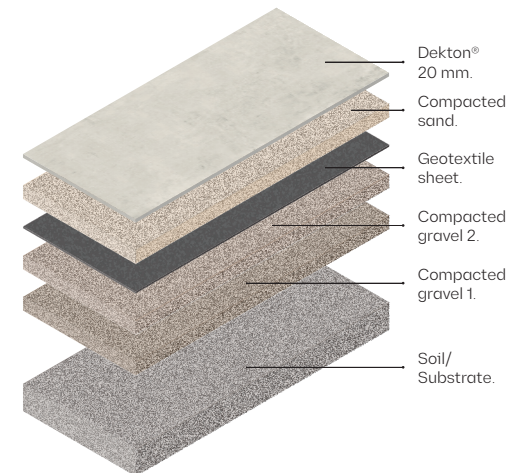

→ Rehabilitation

In this case, the expert or technician in charge of the project will have to assess that both the existing substrate and the substrate underneath are in good condition for laying the flooring.

Otherwise, the necessary preliminary actions must be carried out to guarantee all the basic requirements and conditions in order to be able to lay the flooring on the substrate: flatness, strength, etc.

**Bonded to existing concrete**

- If the height of the floor level can be raised, it is advisable to use a mortar screed with the specific product for this purpose.
- If this is not possible, a surface hardener can be used to reinforce the existing concrete.

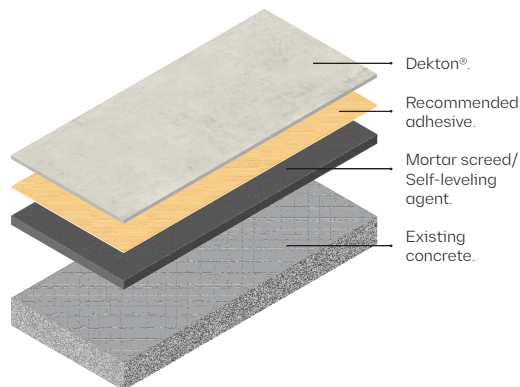

**Bonded to ceramic/stone tiles**

- If the ceramic/stone tiles are well bonded, the new Dekton® flooring can be laid, using a suitable primer before applying the cement-based adhesive.
- If the ceramic/stone tiles are not in good condition, they should be removed and work should be performed on the base surface.

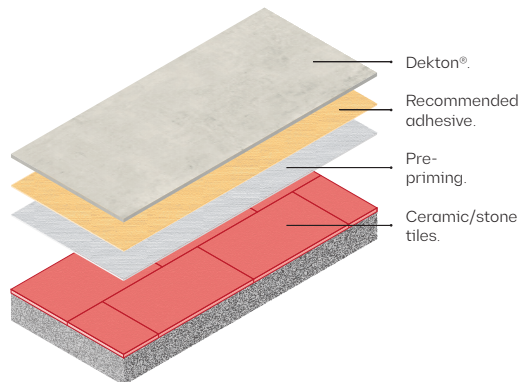

**Bonded to wood, linoleum, etc.**

- Due to lack of ventilation, wood or wood flooring will tend to rot or 'swell' due to moisture accumulation, either because of the characteristics of the application site or because of the moisture present in the adhesive itself.
- In all cases, the existing wood or wood flooring must be removed and, if necessary, the substrate underneath treated.
- If the substrate underneath is also made of wood, it must be treated to prevent it from being affected by the aforementioned moisture.

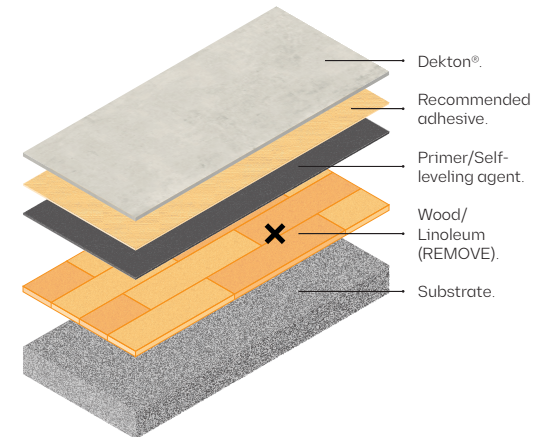

**Bonded on wooden structure**

- In this case, the expert or planner must check that the structure is suitable to support the new Dekton® flooring.
- If the structure contains a wood layer above, it must be removed, as above, and the wooden structure treated on top to prevent it from getting wet.
- If there is another type of finish (ceramic, natural stone, cement, etc.) on the wooden structure, it is sufficient to apply a primer or a self-leveling agent, as appropriate, before applying the recommended adhesive.

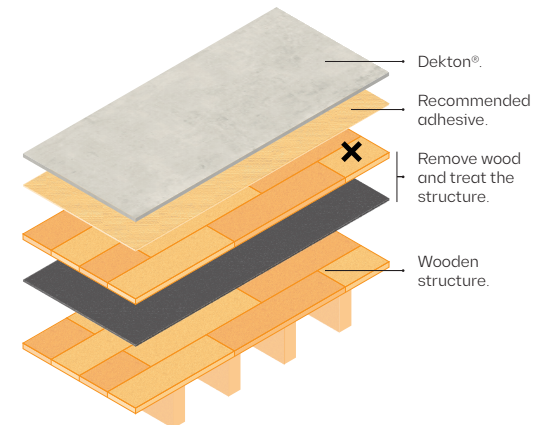



## Thickness and format according to application

Depending on the required application and the thickness chosen, the maximum recommended formats are:

	Use	Thickness		
		8 mm	12 mm	20 mm
Domestic	Outdoor terrace	Half slab <sup>(2)</sup>	Full slab	Full slab
	Indoor flooring	Full slab		
	Raised floor <sup>(1)</sup>	●	●	Half slab
	Underfloor heating	Full slab	Full slab	Full slab
	Swimming pool flooring	Half slab		
	Garage	●	●	
Public & commercial	Outdoor terrace	●	Half slab	Full slab
	Indoor flooring	Half slab	Full slab	
	Raised floor <sup>(1)</sup>	●	●	Half slab
	Underfloor heating	Half slab	Full slab	Full slab
	Swimming pool flooring	●		
	Pavements & squares	●	Half slab	
	Car dealer	Half slab	Full slab	
	Car parking	●	●	Half slab

→ (●) Not recommended.  
 → (1) Material must be supplied with mesh on the back side (Dekton® Protek).  
 → (2) A rigid and stable support, similar to that which would exist indoors, is mandatory.



→ Full slab.



→ Half slab.



→ Slab cut into strips.  
(This is **NOT** a half slab)

## Dekton® Grip/Grip+

It is our solution to achieve a better adherence for any anti-slip application such as bathrooms, swimming pools or outdoor flooring.

Each environment has different technical requirements. Therefore, we are launching a new portfolio of anti-slip floors in two different finishes: Grip and Grip+.

The new Grip/Grip+ technology modifies the surface structure of Dekton® in a controlled manner, obtaining a homogeneous, highly durable and resistant anti-slip surface without the need of chemical or mechanical means.

To know the colors available with Grip/ Grip+ finish, please consult the most updated published portfolio.

For further technical details of the material, please refer to the product *Technical Data Sheet*.

### → Grip

- Recommended in applications where a less demanding anti-slip is required, due to its greater ease of cleaning.
- Ideal for spaces with light colors.
- R10 classification for dry ramp, Class B for wet ramp and Class 3 according to pendulum test.
- Recommended application examples: Indoor areas such as shopping malls, airports, stairways, medical rooms, dining rooms, companies, schools, bathrooms, shower trays and residential use in general.

### → Grip+

- Maximum adhesion for the most demanding applications.
- R11 classification for dry ramp, Class C for wet ramp and Class 3 according to pendulum test.
- Recommended application examples: Outdoor areas such as swimming pools, shopping mall entrances, airports, outdoor stairs, terraces and public use in general.

These non-slip finishes may have slight chromatic or tone differences with respect to the standard color finish.

It is recommended to strictly follow the use, cleaning and maintenance recommendations for these finishes.

→ Errors in the installation, use, cleaning and maintenance of Dekton® with Grip/Grip+ anti-slip finish can significantly affect its performance. Defects or loss of performance due to any installation, use, cleaning and maintenance operations that are not specified in the corresponding manuals, available for the customer at [www.cosentino.com](http://www.cosentino.com) or by request to [info@cosentino.com](mailto:info@cosentino.com), will be excluded from the Dekton® warranty applicable to these products.

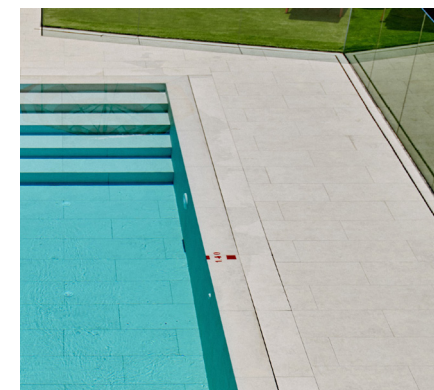

→ Hard Rock Hotel (Madrid, Spain), Restaurants.

## Joints

A key factor in ensuring the successful design and installation of the flooring is a thorough analysis, including layout and dimensions of the joints. Below are some examples:

### → Grout joints

Dekton® tiles should never be installed without grout joints.

These joints must always be at least:

- **2 mm [1/16"]** for indoor applications and **3 mm [1/8"]** for outdoor applications, taking into account the expansion of the material.
- **4 mm [1/8"]** for raised floor.
- **5 mm [3/16"]** for 20 mm tiles on sand.



### → Perimeter joints

They are found in encounters with walls, pillars, etc.

At least **4 mm [1/8"]** is recommended.



### → Expansion joints

They will be placed in areas of 50 m<sup>2</sup> [538 sqft], reducing these areas in the case of slabs with metal structures or significant deformations.

For filling expansion joints, **elastomeric materials** can be used, according to the manufacturer's instructions, as well as **suitable ready-made profiles**.



### → Structural joints

They must always be used, both in the substrate and in the flooring.

These joints must be sealed using **elastomeric materials** or **suitable ready-made profiles**.

A size of **3 - 4 mm [1/8"]** is recommended.

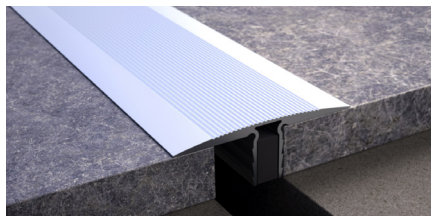

## On-site/Workshop placement

### Palletizing and transport of material to the construction site/workshop

To facilitate the storage and transport to the construction site/workshop, Dekton® tiles are supplied in specially designed wooden frames or crates according to their formats.

The material is then strapped to the crate and placed on a non-slip surface to prevent sudden movements.

Whenever the flooring is of a single format, it will be packed in pallet-size crates, weighing no more than 1,500 Kg [3,300 lb].

If larger in size or with various formats, vertical A-Frames are used, with the tiles correctly arranged.

For the handling of the tiles on site, appropriate safety measures must be taken to remove and move the tiles one by one, using the necessary means of support.

It is especially important to use suitable suction cups depending on the size and weight of the tile.

Glass-type suction cups with suction pump are recommended.



→ Packaging in a crate for large-format flooring.



→ Packaging on A-Frame for flooring or various formats.



→ Handling with suction cups for large-format tiles.

# Manufacturing & installation

## Cutting tiles in the workshop

Although the tiles for flooring projects are usually supplied already cut by Cosentino®, it is always possible for the client to be supplied with full slabs and to cut them themselves with waterjet or CNC machines, among others.

In this case, the diagram below shows some of the key points to consider for the design regarding the cut.

Workshop cutting is possible for 8, 12 and 20 mm thicknesses.

All the information on manufacturing can be found in both the *Fabricator Quick Guide* and the *Approved Tool Sheets* for Dekton®, which Cosentino® has published.

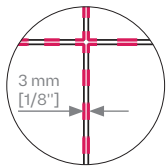
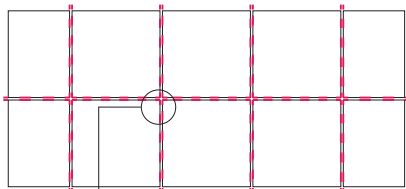

→ Approximately 3 mm [1/8"] of material (width of the cutting disc) is lost per cut.

→ Transport from the workshop to the installation site

### Before loading - Quality control

Standardized template with quality control, including: number of tiles, appropriate dimensions, possible material defects, presentation of tiles to check joints, etc.

### Transport by truck

Place the material, with all edges and corners protected, vertically on A-Frames, securing them with canvas slings and protecting the ratchets.

Special care must be taken with tiles which include cut-outs/drills made in the workshop.

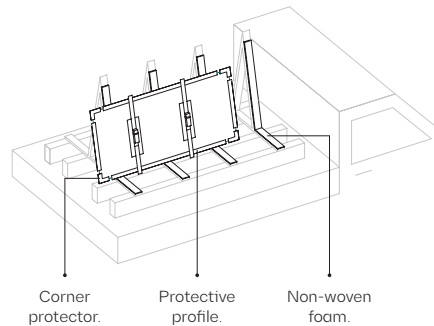

### Movement with manual suction cups

Use elements that strengthen and facilitate the handling of the material.

Tiles must always be transported one by one in a vertical position, and manual handling with suction cups must be carried out with bars that keep the tile straight and free of warping.

## Cutting tiles on site

As mentioned above, the tiles can be supplied cut to size by Cosentino®. However, for on-site adjustments, cuts and drill holes can be made with the appropriate tools to deal with design changes, corners, pillars, etc.

### → Dry straight cutting

On-site straight cutting is possible using dry cutting machines. We recommend the use of polishing blocks to micro-bevel the tiles.

This type of on-site cutting is only recommended for thicknesses of 8 mm for lengths up to 3,200 mm [126"], and 12 mm for lengths up to 1,400 mm [55"].

Please refer to the *Dekton® Cutting Manual* for basic advice on how to cut as well as the recommended tools.



→ Dry straight cutting.



→ Dry straight cutting-type tools.

### → Straight cut with water supply

Cutting with disc and water supply is also possible for thicknesses between 8 and 20 mm.

However, the following requirements must be met:

- Use cutting tools recommended by Cosentino®.
- Always cut with water supply.
- Sharpen the tool regularly.



→ Straight cut with disc and water supply.

### → Circular cut-outs

Circular cut-outs (e.g for small electrical sockets) are possible.

The distance to any joint, edge or corner must be at least 50 mm [2"].

Square/Rectangular cut-outs (e.g. for floor access panels) are not allowed. Please refer to the section 'Other considerations'.

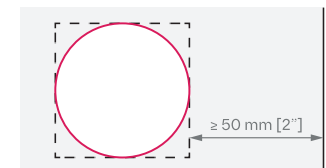

## Basic characteristics of adhesives and grouts

With regard to the bonding or adhesive material, it is essential to consult with the selected local supplier prior to installation and to faithfully follow their product recommendations and application instructions.

Dekton® has a low thermal expansion coefficient, so an improved cement-based adhesive of Class C2 is sufficient. Conventional cement, such as that used for natural stone, should not be used because the material is non-porous and the evaporative setting is ineffective.



Consult the *Product Approval Sheets* for recommended adhesives, published by Cosentino® and made in conjunction with the main brands, according to the following parameters:

Application place	Substrate	Size
Indoors	Cementitious or anhydrite screed, self-leveling product, concrete, fiber-cement panel, old ceramic, stone	≤ 750 x 750 mm [30" x 30"] > 750 x 750 mm [30" x 30"]
	Heated screed	All sizes
	Wood, OSB, MDF	
	Metal, resin, rubber, linoleum	
Outdoors	Cementitious screed, concrete	≤ 750 x 750 mm [30" x 30"] > 750 x 750 mm [30" x 30"]
	Metal	All sizes

The same is valid for the joint mortar or grouting material:

Application place	Substrate	Size
Outdoors	All surfaces	All sizes
Indoors	All surfaces	All sizes
Heated screeds	All surfaces	All sizes

## Tools for manufacturing and installation

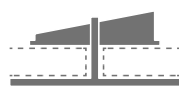
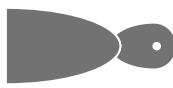
			
→ Workbench.	→ Clamps.	→ Tape measure.	→ Spirit level.
			
→ Dry cutting machine.	→ Approved drill and drill bits <sup>(1)</sup> .	→ Cutting machine <sup>(1)</sup> .	→ Angle grinder <sup>(1)</sup> .
			
→ Polishing block.	→ Suction cups.	→ Recommended adhesive.	→ Plastic trug.
			
→ Mixer.	→ Mixing trowel.	→ Toothed trowel.	→ Leveling kit.
			
→ Grouting kit.	→ Water supply.	→ Recommended cleaning agent <sup>(2)</sup> .	→ Cleaning sponge.

→ (1) Always use with localized suction/water supply.

→ (2) Consult the corresponding *Use & Care Manual* (Dekton® flooring or Dekton® Grip/Grip+).

## Installation process and recommendations

Laying of tiles must always be done considering the characteristics of the adhesive (open time, lifetime, maximum application thickness, etc.) as well as the manufacturer's instructions.

### 1. Preliminary check of the substrate

Before any work is carried out, it must be checked that:

- The substrate is clean.
- The substrate is dry.
- The substrate is leveled.

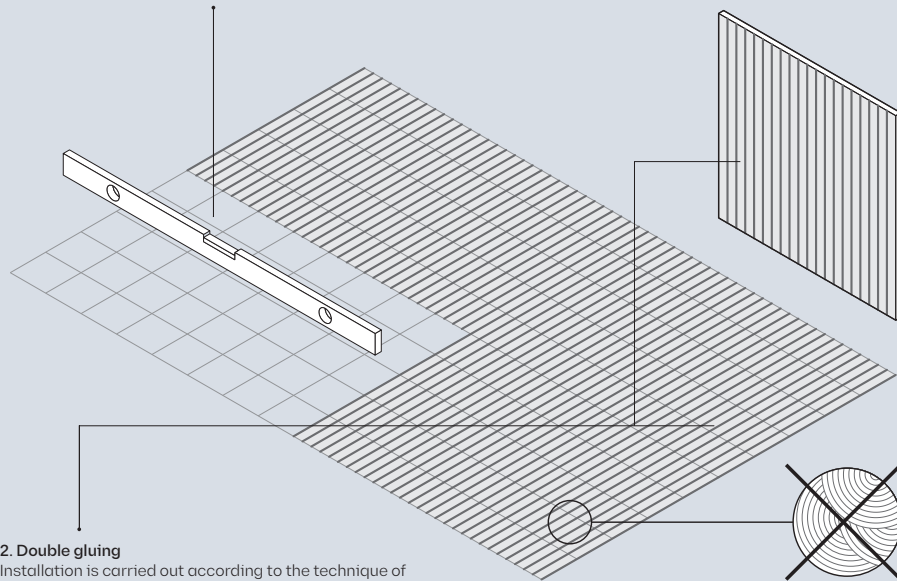

### 2. Double gluing

Installation is carried out according to the technique of 'double gluing' (adhesive on the back of the tile and on the substrate), which ensures perfect adherence and prevents gaps from forming.

Never apply the adhesive by 'sticking' or 'pinching'.

This technique has several advantages:

- It allows for a greater distribution of stress by ensuring the maximum possible contact surface (> 90%) between the substrate and the adhesive and the adhesive and the tile.
- It avoids the formation of efflorescence by preventing the eventual stagnation of rainwater on the surface of the tile.
- For this reason, in outdoor flooring, the possibility of frost formation and breakage due to this effect is avoided.

The application, both on the substrate and on the tile, would be according to the following diagrams:

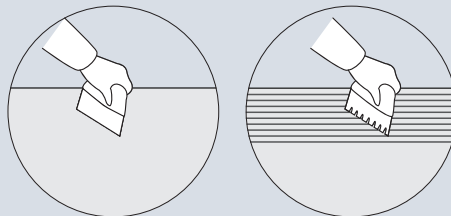

1. Application with the smooth side of the trowel.

2. Combing with the toothed part of the trowel.

### 3. Toothed trowel and direction of the adhesive line

The combing should always be done with a toothed trowel to define its geometry according to the tile format, the substrate and the type of adhesive. This ensures adequate adhesive thickness and good distribution along the surface, including perimeters.

**DIRECTION:** In the case of large format tiles (> 750 x 750 mm [30" x 30"]) and with a prominent length (2:1 ratio or greater), the adhesive line must be parallel to the long side in order to be able to move the laid tile with suction cups a few centimeters in the shorter direction of the tile and to ensure the 'flattening' of the adhesive lines with the sliding movement.

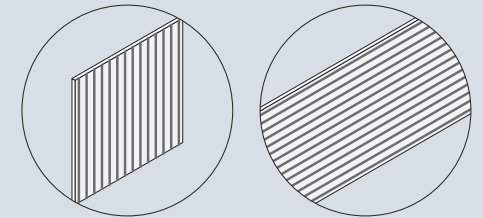

→ Small format.  
(≤ 750 x 750 mm [30" x 30"])

→ Large format.  
(> 750 x 750 mm [30" x 30"])

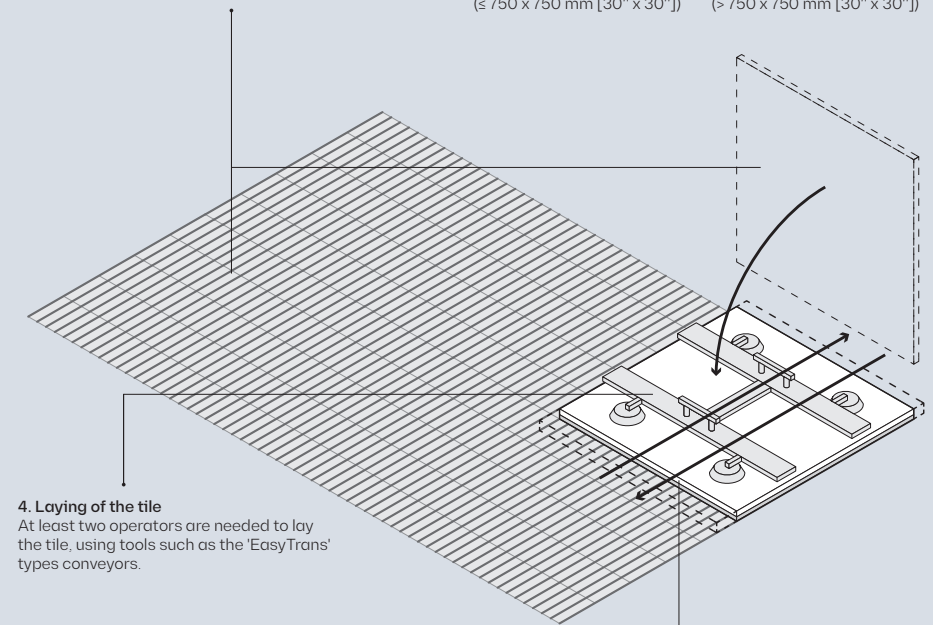

### 4. Laying of the tile

At least two operators are needed to lay the tile, using tools such as the 'EasyTrans' types conveyors.

### 5. Sliding movement

To allow air to be released and better contact between the tile and the substrate, reversible sliding movement must be employed and not 'hammering'.

The process is as follows:

1. Place the tile in its final position.
2. Move the tile perpendicularly to the adhesive lines in proportion to the width of the trowel tooth.
3. Put it back in place, keeping to the width of the marked joint.

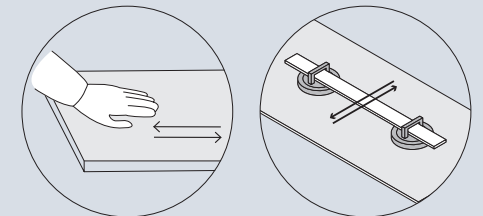

→ Manually for small formats.

→ Mechanically for large formats.

**6. Edges with bevel**

The edges must always have a micro-bevel of at least 1 mm [1/32"]. In other more specific cases, such as on raised floors, larger rounded bevels and corners are recommended.

They can be supplied ready-made or, in the case of cutting and adjusting on site, this can be done by means of a polishing block.

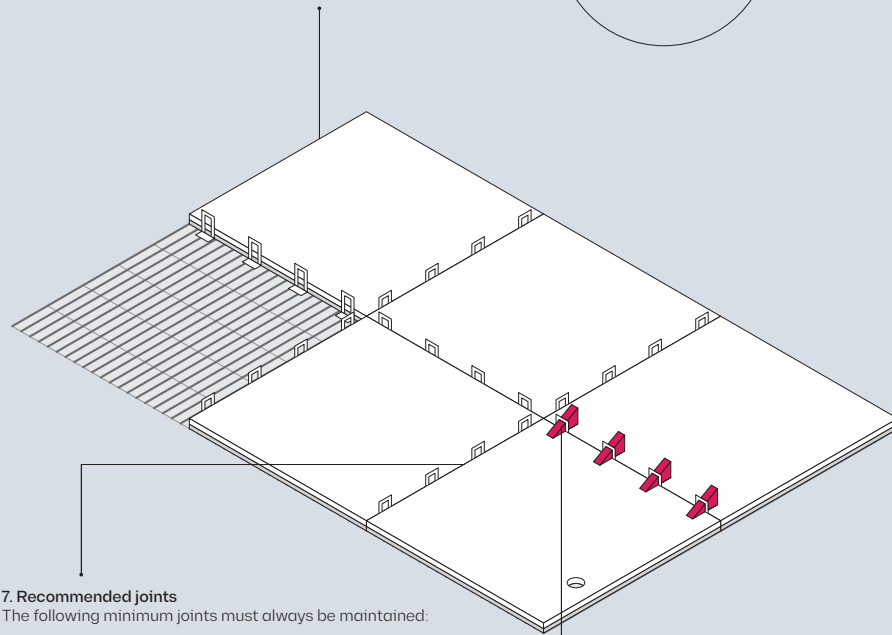
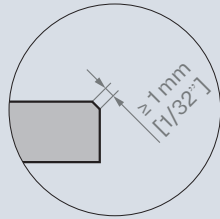

**7. Recommended joints**

The following minimum joints must always be maintained:

- Grout joints (indoors)  $\geq 2$  mm [1/16"].
- Grout joints (outdoors)  $\geq 3$  mm [1/8"].
- Perimeter joints  $\geq 4$  mm [1/8"].

*This type of joint is very important in the encounters with recessed elements due to the different expansion between materials.*

- Structural joints  $\geq 3 - 4$  mm [1/8"].
- Expansion joints: every 50 m<sup>2</sup> [538 sqft] of surface.

*For these two types of joint, the use of suitable ready-made profiles is recommended, especially in high transit areas.*

The use of spacers is recommended in order to comply with the stipulated joint width.

For other types of construction solutions, respect the following minimum joints between tiles:

- For raised floor  $\geq 4$  mm [1/8"].
- For floating floor over sand  $\geq 5$  mm [3/16"].

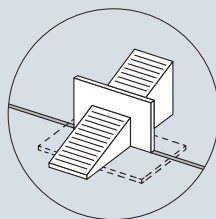

**8. Auxiliary systems**

When laying large format tiles, the use of auxiliary systems to improve the final leveling of the flooring is recommended, such as leveling wedges, ensuring regular thickness of the adhesive layer.

**9. Grouting material**

When filling the joints, the appropriate grout and consistency should be chosen and applied according to the manufacturer's instructions.

It is advisable to use a rubber trowel of the appropriate hardness to the width of the joint to extend the material diagonally to the direction of the joints.

The final texture and curvature will be set on the joint using a pointing trowel or equivalent tool.

In some cases, flexible stainless steel scrapers or extrusion guns can be used to apply the grout.

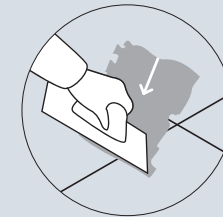

1. Application of the grout with trowel.

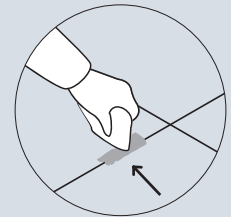

2. Making curve and texture.

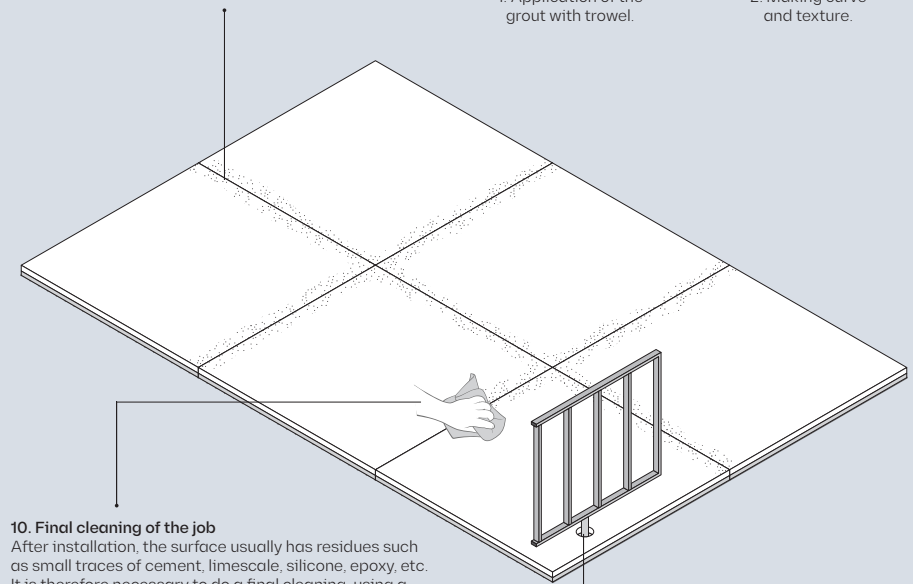

**10. Final cleaning of the job**

After installation, the surface usually has residues such as small traces of cement, limescale, silicone, epoxy, etc. It is therefore necessary to do a final cleaning, using a specific cleaning product (e.g. Deterdek Pro by Fila or equivalent), which will leave the surface clean without damaging the grout.

Follow the recommendations established in the *Dekton® Flooring Use & Care Manual*, both for standard finishes and for anti-slip Grip/Grip+ finishes: cleaning procedures, reference products, restrictions, etc.

**VERTICAL ELEMENTS**

When installing vertical elements (e.g. a railing support) within a cut-out, whether it is square/rectangular or circular, enough space must be left to prevent contact between the tile and the vertical element.

Trim covers can be used to hide the gap.

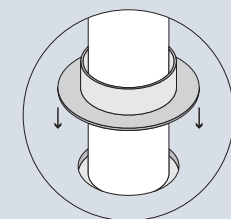
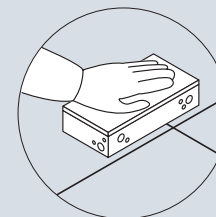

## Health & safety

Operators and fitters dealing with Dekton® materials, must comply with all applicable occupational health and safety laws and regulations.

Always take the necessary occupational safety measures to meet the requirements of local regulations. This *Guide* is not an exhaustive document or a substitute for the relevant laws and regulations, and is provided for information purposes only.

Safety measures will depend on the specific conditions of each job.

### Risks associated with handling and transport

During transport and handling of Dekton® materials, risks such as bumps, cuts, musculoskeletal disorders, entrapment or blast injuries can occur due to incorrect handling.

### Risks associated with manufacturing and transformation

The manufacturing process can involve risks such as cuts, blast injuries, entrapment, exposure to high noise levels and exposure to chemicals such as free crystalline silica dust.

Before processing the product, consult the Dekton® *Safety Data Sheet* and the *Good Practice Guidelines* available upon request from Cosentino® or on the website [osh.cosentino.com](http://osh.cosentino.com).

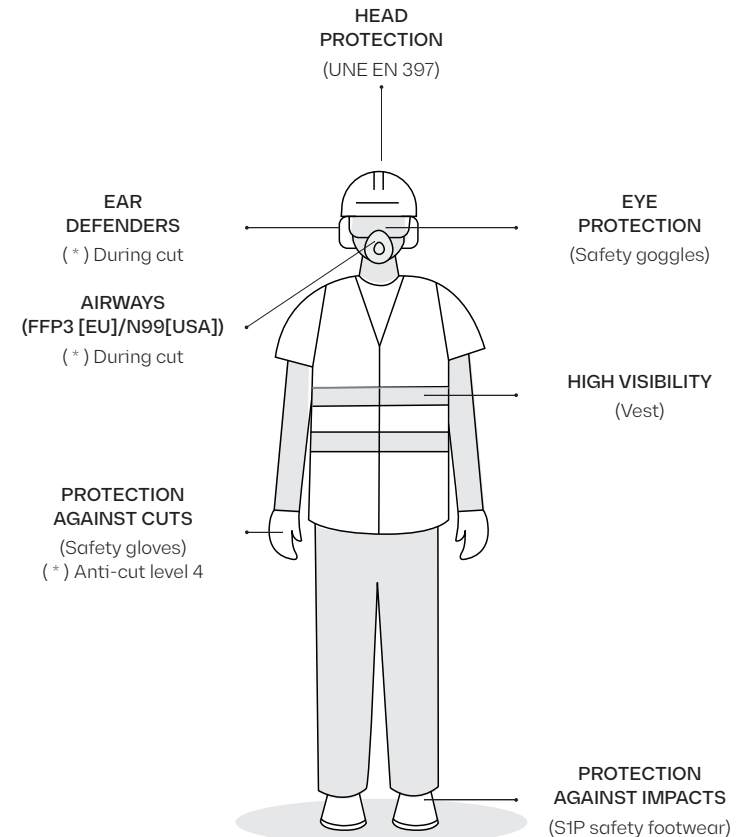

## COSENTINO®

Ctra. Baza a Huerca-Overa, km 59 / 04850  
Cantoria - Almeria (Spain) / Tel.: +34 950 444 175  
info@cosentino.com / www.cosentino.com



→ These certificates apply to  
Dekton® and Silestone®

REV. 06 - 01/2024

PRINT DATE: JANUARY 2024